

Digital Camera

Manual

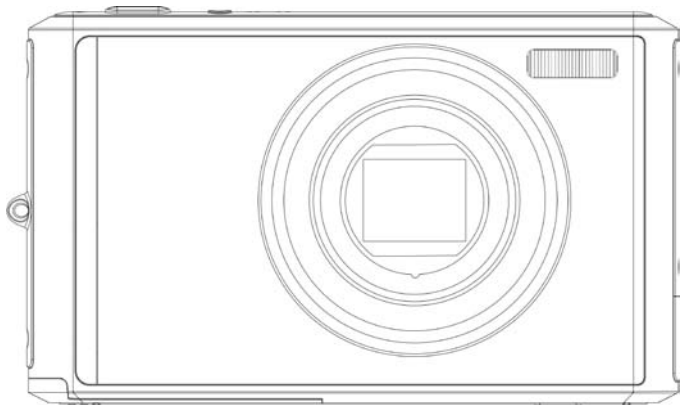

Please read this manual carefully before use

And keep it for future reference

Table of Contents

Introduction	3
Key Features.....	3
What your camera package includes	4
Computer System Requirements for Windows XP.....	4
Computer System Requirements for Windows Vista	5
Computer System Requirements for Macintosh.....	5
A Quick Look at Your Camera.....	6
Preparing Your Camera for Use.....	7
Install lithium battery	7
Installing SD Memory Card	9
How to hold your camera correctly when capturing images	11
Starting Your Digital Camera	12
Camera Mode.....	13
Video Mode	35
Playback Mode	38
Download photos and videos to your PC	48
Viewing Videos.....	53
Transferring photos and videos to your PC manually	54
Transferring photos and videos to your MAC manually	55

Maintenance of Your Digital Camera	56
Appendix A: Technical Specifications	56
Appendix B: Troubleshooting	57

Introduction

Thank you for purchasing the 8.1 Mega-Pixel Digital Camera with Auto-Focus zoom lens. Everything you need to take quality High Definition digital photos and videos is included with your camera.

Your digital camera can also be used as a removable disk when an SD card of up to 8GB is inserted into the camera.

Vivitar makes capturing those special moments so easy. It enriches your life.

Please read this manual carefully first in order to get the most out of your digital camera.

Key Features

- Digital Video resolutions-640x480 Pixels (VGA), 320x240 Pixels (QVGA).
- 8.1 mega pixels camera with choice of 6 digital camera resolutions - (8M) 3264x2448pixels, (7M HD) 3648x2048 pixels, (5M) 2592x1944 pixels, (3M) 2048x1536 pixels, (2M HD) 1920x1080 pixels and (VGA) 640x480 pixels.
- 2.4 inch TFT LCD
- Auto Focus Zoom Function
- 8x Digital Zoom Function
- Anti-Shake
- Face Detect
- SD memory card slot compatible with memory card up to 8GB.
- Built in Flash
- PhoTags Express software for managing and enhancing your photos, printing, sending photos by e-mails and much more.

What your camera package includes

- Digital Camera
- PhoTags Express software Installation CD
- USB cable
- Quick Start Guide
- Strap
- Lithium Rechargeable battery
- Charger

Computer System Requirements for Windows XP

To be able to download photos to your PC, you will need the following minimum configuration:

- Pentium III process or above with Windows XP
- 128 MB RAM, with 150MB of free disk space
- Available USB interface
- CD-ROM Drive
- 1024 x 768 Recommended screen resolution
- 16-bit color or higher display adaptor

Computer System Requirements for Windows Vista

To be able to download photos to your PC you will need the following minimum configuration:

- Windows Vista
- 800MHz processor and 512 MB of system memory
- 20GB hard driver with at least 15GB of available space
- Support for Super VGA graphics
- Available USB Interface
- CD-ROM drive

Computer System Requirements for Macintosh

- Power Macintosh G3 500 MHz or higher
- Mac OS X version 10.2.6 or later
- 128 MB or more available system RAM (256 MB recommended), 150 MB free disk space
- 800 x 600 or higher-resolution monitor displaying millions of colors

Note: The Photags Express software is not compatible on Macintosh computers. You may however use the camera as a regular MSDC USB removable device.

A Quick Look at Your Camera

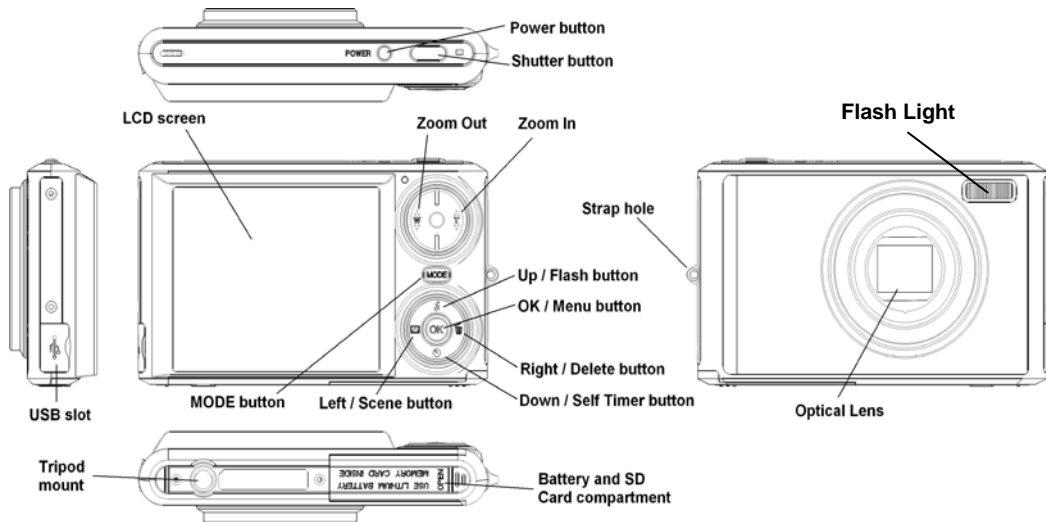

Preparing Your Camera for Use

Install lithium battery

Your digital camera needs a lithium Li-ion battery in order to operate. The battery is found separately in the packaging. To install it correctly see the diagram below:

1. Slide and open the battery door on the bottom of the camera.

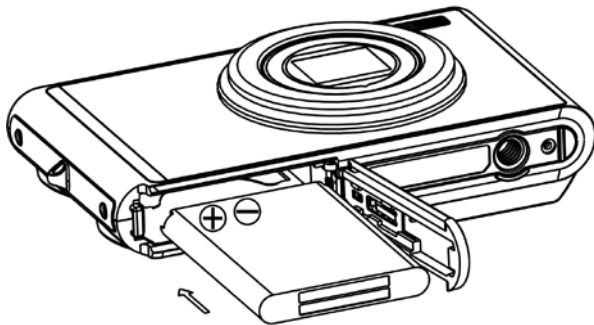

2. Insert the battery correctly with the correct polarity facing up.
3. Use the battery clip found in the battery compartment to make sure that the battery is sitting firmly.
4. Close the battery door.
5. On powering on your camera the battery icon will appear on the bottom right of the LCD screen.



Full battery power



Medium battery power



Low battery power

Note:

- 1. In order to charge your lithium battery, make sure the battery is inserted correctly and then connect your camera to an on and running PC with the USB cable provided. The red LED will light up indicating that your camera is in charging mode. The LED will switch off when your camera is fully charged.**
2. A “Low battery” message will flash on the LCD when the battery power is insufficient. Shortly thereafter your camera will power off.
3. Please remove your battery when you don't intend to use your camera for a long time.
4. Test photos taken with the camera should be downloaded otherwise they will be lost when the camera loses power and turns off or when the battery door is opened to replace the battery.

Installing SD Memory Card

Your camera has very limited internal memory enough to take one test photo.

An external memory card is required for normal use. Your camera supports any compatible SD memory card (up to 8GB).

Adding a memory card will allow you to increase the capacity of your camera before transferring the photos and videos to your PC.

1. Locate the Memory Card slot situated in the battery cover at the bottom of the camera.
2. Insert the Memory card into the slot in the correct direction.

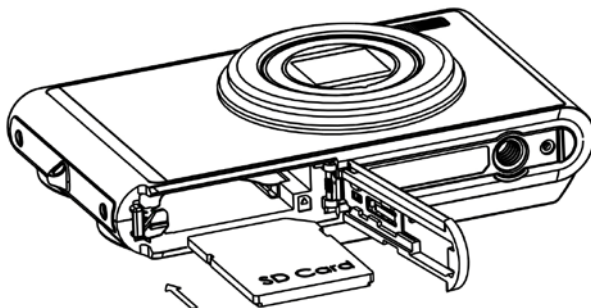

3. Push the card in until you feel it "click" into position. An SD icon will appear on the bottom of the LCD screen after you turn on your camera.
4. Once the external memory card is inserted into the camera all the images taken with the camera will be stored on the card.

5. Please make sure the card is not locked. No images can be transferred to the card if it is locked.

Note:

1. Limited internal memory is provided for test images. The images will be deleted when the camera's power is turned off or if the batteries are removed. Please download the images before powering off.
2. If there is a photo in the internal memory when you insert the card into your camera, a "Copy to card" message will appear on the LCD with Yes or No options. On selecting 'Yes' the photo will now be copied to your card.
3. Formatting will delete all data on the SD memory card including protected data.
4. Don't remove the SD card during formatting as this may damage the card and render it unusable.
5. When your card is full, download the media on the SD card to your PC and delete the photos and videos from it in order to continue using your camera to capture more high quality photos and videos.

How to hold your camera correctly when capturing images

Turn on the Power button to activate the Auto- Focus zoom lens to open out like a periscope.

Hold the camera steady and correctly as shown in the diagram below.

Note: Do not touch or move the lens once it opens and is in use. This will cause damage to the camera.

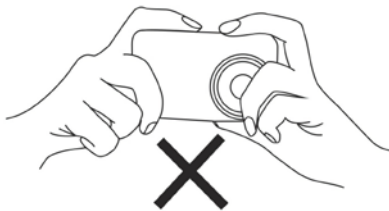
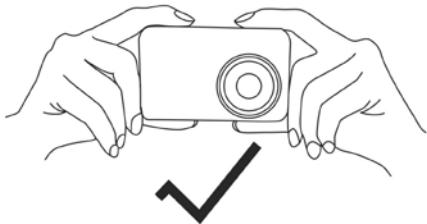
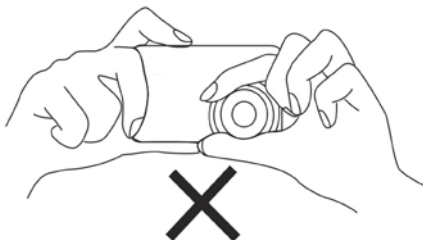
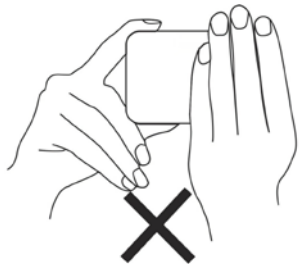

Starting Your Digital Camera

Power on



Press the Power button on the top of the camera to turn on your camera. The LCD will light up and the Auto-Focus zoom lens will extend out indicating that your camera is on and ready for use.

Power off

Press the Power button to turn off your camera. When there is insufficient battery power a red icon  will appear on the LCD screen. Your camera will automatically power off after a few seconds.

Mode selection

Your digital camera has 3 main modes - Camera mode, Video mode and Playback mode.

-  The Camera mode is for you to take still photos, adjust the camera settings and change the way the camera is setup.
-  You can shoot video files while in Video mode.
-  In Playback mode you can preview photos and videos as well as being able to delete, rotate, protect, crop and print your photos.

In order to select the mode, please follow the below steps:

1. By default the Camera mode appears first on powering on the camera.
2. Press the MODE button to toggle between the 3 modes.
3. The Camera mode will have a  icon in the top left corner of the LCD screen. The Video mode will

have a  icon and the Playback mode a  icon will appear in the top left corner of the screen.

Camera Mode

This is the default mode when turning on your camera.

Taking Photos

1. Compose your shot using the LCD screen.
2. Hold the camera steady and press the Shutter button to take the photo.
3. Keep your finger on the Shutter button and wait for the camera to focus in on the object.
4. Center your object with the white frame that appears on the LCD.
5. When the frame turns green lift your finger and the image will be captured.
6. There will be a short delay while the camera saves the JPEG photo to memory.

After each photo is taken (when the camera returns to icon mode) the numbers of photos left to shoot at the selected resolution is displayed on the top right of the LCD screen.

- When the camera's memory (photo capacity) is full, the LCD screen will display a message - "Memory Full, Insert a SD memory card to Transfer and Take More Photos!"
- Download the photos to your computer using the Photags Express software as described below in the section "**Download photos and videos to your PC**" and thereafter delete them from your SD card or insert another SD card to continue taking more photos.

Note: This camera needs a SD memory card to operate normally. The limited internal memory allows you to take one test photo that will be erased when the camera powers off.

Auto-Focus Zoom

You can magnify your subject using the Auto-Focus zoom by pressing the T button or press the W button to zoom back out.

Note: When using this function, the camera will automatically adjust the lens. Be careful not to touch the lens while the camera is adjusting.

Digital Zoom

You can magnify your subject up to 8 times using the digital zoom. Press the T button to zoom in on the object and press the W button to zoom back out.



The following icon will appear on your LCD screen.

Flash



In low light conditions it is best to use the built-in flash. You can also use the flash to compensate for

backlight conditions.

 Force Flash,  Auto,  Red eye reduction,  No Flash



To set the flash:

Note: Please move the Macro/Far setting to Far mode. The flash can only be used when the camera is in Far mode. If you are in the Macro close up mode and try to use the flash, a message will appear on the LCD to remind you that you are in "Macro Mode". Select the Macro setting option to change to the Far mode in order to use the flash.

1. Press the Flash/Up button.
2. The  icon appears on the LCD screen. This will activate the automatic flash.
3. The  icon as well as the red LED will begin to flash indicating that the flash is charging.
4. Press the Flash button again for the  icon to appear on the LCD screen. This means the flash function has been "forced on" (manual flash).

If the flash is not ready, a red LED will light up and the  icon will flash repeatedly- wait until the flash is ready before taking a photo.

Note: A "low battery" warning will appear on the LCD screen if there is insufficient battery power to operate the flash.

5. Press the Flash button until the  icon appears on the LCD indicating that the Red-Eye reduction is on.
6. Press the Flash button until the  icon appears again. This will turn off the flash function. This is the default flash setting.

Short cut buttons on the OK/MENU dial

The camera has 3 short cut buttons on the OK/MENU dial to make for quick access to the following settings: *Scene (Left button), Self-timer (Down button) and Delete (Right button)*

Pressing the relevant button will activate the setting options.

- **Scene** – the 9 scene options appear on the LCD for you to select:
Auto, Night Portrait, Night Scenery, Portrait, Scenery, Sport, Party, Beach, High Sensitivity
- **Self-timer** – Press the Self-timer button to toggle through the 4 self-timer options that appear on the top of the LCD:
2 sec, 5 sec, 10 sec or Off
- **Delete** – Pressing this button will delete the last image (Photos or Videos) captured.
 1. Press the Delete (Right)  button.
 2. A “This Image” delete confirmation message appears on the LCD with “Yes” or “No” options.
 3. Press the Left/Right button to choose “Yes” to delete the photo or “No” to cancel the delete.
 4. Press the OK/MENU button to confirm.
 5. If you selected “Yes”, the last image is deleted.

Each setting will be explained in its own section below.

Scene

Your camera comes supplied with many scenes for you to take photos in accordance with the light and environmental conditions prevailing at the time of taken the photo. Scene included with your camera are - *Auto, Night Portrait, Night Scenery, Portrait, Scenery, Sport, Party, Beach or High Sensitivity.*

1. Press the OK/MENU button.
2. Press the Right/Left button to select the Scene  icon.
3. The Scene menu appears in the center of the LCD.
4. Press the Up/Down buttons to select the scene you want to use.

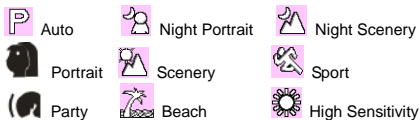

5. Press the OK/MENU button to confirm, save your choice and exit to the camera standby mode.
6. The selected icon appears next to the camera icon on the top left of the LCD screen.

Image Size

The image size settings determine the quality and number of photos that can be saved and the amount

of memory required for each photo. The higher the photo quality the more memory it will take. The image size and quality will also affect the maximum size you can effectively print your photo. To set the Image size:

1. Press the OK/MENU button.
2. Press the Right/Left button to select the **MP** icon.
3. The Image Size menu appears in the center of the LCD.
4. Press the Up/Down buttons to select the image size you want to use.
(8M) 3264x2448, (7M HD) 3648x2048, (5M) 2592x1944, (3M) 2048x1536, (2M HD) 1920x1080 and (VGA) 640x480
5. Press the OK/MENU button to confirm, save and exit to the camera standby mode.
6. The selected image size icon will appear on the top of the LCD screen.

Note:

1. For Image sizes higher than 3M a SD card need to be inserted into the camera.
2. Your camera has two HD "7M" and "2M" high definition image sizes.

Anti-Shake

Your Digital Camera has a function that prevents photos coming out blurry as a result of trembling or shaking when taking the photo. You are not required to use a tripod in order to take good quality photos.

1. Press the OK/MENU button.
2. Press the Right/Left button to select the  icon
3. The Anti-Shake menu appears in the center of the LCD.
4. Press the Up/Down button to select Anti-Shake *On or Off*.





5. Press the OK/MENU button to confirm, save and exit to the camera standby mode.
6. The Anti-shake option  icon selected will appear on the bottom of the LCD screen.

Macro/Far shooting

The camera has the function that allows you to capture objects with the Hyperfocal distance setting of either Macro very near (up to 30cm) or very Far distances.

1. Press the OK/MENU button
2. Press the Right/Left button to select the  icon.
3. The Macro menu appears in the center of the LCD.
4. Press the Up/Down button to select Macro *On or Off*.

 : Macro shooting - On

 : Far shooting - Off

5. Press the OK/MENU button to confirm, save your choice and exit to the camera standby mode.
6. The selected icon appears on the top of the LCD screen.

Note: The camera is by default in Far shooting mode.

Face Detect

Your camera supports face detecting that allows you to take better portrait photos.

1. Press the OK/MENU button.
2. Press the Right/Left button to select the  icon.

3. The Face Detect menu appears in the center of the LCD.
4. Press the Up/Down button to select Face Detect *On* or *Off*.

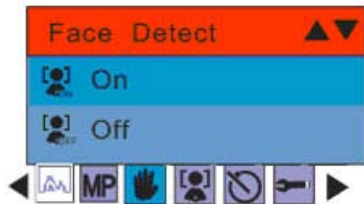

5. Press the OK/MENU button to confirm, save your choice and exit to the camera standby mode.
6. The Face Detect On or Off icon selected will appear on the bottom of the LCD screen.

Self-Timer

You can include yourself in a photo by using this feature to delay the time between you pressing the Shutter button and when the photo is actually taken. It is recommended that you use a tripod or place the camera on a flat and sturdy surface when using the self-timer.

1. Press the OK/MENU button.
2. Press the Right/Left button to select the  icon.
3. The Self -Timer menu appears in the center of the LCD.

4. Press the Up/Down button to select one of the self timer options:



5. Press the OK/MENU button to confirm, save your choice and exit to the camera standby mode.
6. The Self-Timer icon selected will appear on the top of the LCD screen.
7. Press the Shutter button until you see the self-timer count-down begin in the center of the green frame that appears on the LCD. Your camera will count down 2, 5 or 10 seconds as per your choice. the camera will emit beeps for each second of the countdown before the photo is automatically taken.

Setup

You can adjust the way your camera is setup with the following setup option:

Exposure, ISO, White Balance, Sharpness, Quality, Date, Auto Power off, Frequency, Language, Copy, Format and Default Setting.

1. Press the OK/MENU button.
2. Press the Right/Left button to select the  icon.
3. The Setup menu appears in the center of the LCD.
4. Press the Up/Down button to select one of the setup submenu options:



Exposure

This setting allows you to control the brightness of your images.

1. Press the OK/MENU button.
2. Press the Up/Down buttons to select an Exposure value (from 3 brightest to -3 darkest) from the menu that appears:

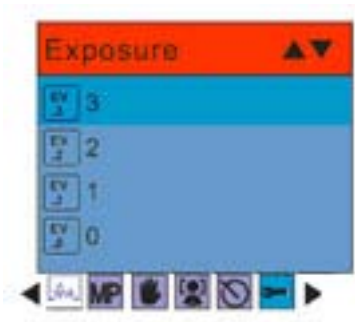

3. Press the OK/MENU button to confirm, save and exit to the camera standby mode.
4. The Exposure icon for the option you selected appears on the bottom of the LCD.

ISO

This is a special function that allows you to compensate the light conditions when the light source is not good and you also specifically do not wish to use a flash or tripod. When using ISO sensitization, please choose the low value ISO to prevent spots or blotches appearing on your photo.

1. Press the Up/Down buttons to select the ISO option in the Setup menu.
2. Press the OK/MENU button.
3. Press the Up/Down buttons to select an ISO value from the menu that appears:



4. Press the OK/MENU button to confirm, save and exit to the camera standby mode.
5. The ISO icon for the option you selected appears on the bottom of the LCD.

White Balance

This setting allows the camera to adjust the color of your photos according to the color of your light source.

1. Press the Up/Down buttons to select the White Balance option in the Setup menu
2. Press the OK/MENU button.
3. Press the Up/Down buttons to select a White Balance option from the menu that appears:

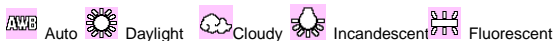



4. Press the OK/MENU button to confirm, save and exit to the camera standby mode.
5. The LCD screen will be adjusted as per the White Balance option you selected.

Sharpness

This setting allows you to adjust the sharpness of your images, making edges more or less distinct.

1. Press the Up/Down buttons to select the Sharpness option in the Setup menu
2. Press the OK/MENU button.
3. Press the Up/Down buttons to select a Sharpness option from the Menu that appears:



4. Press the OK/MENU button to confirm, save and exit to the camera standby mode.
5. The LCD screen will be adjusted as per the Sharpness option you selected.

Quality

The quality of your photos also affects the number of shots you can take. A HIGH setting means you can take fewer photos, but they will be of better quality. The default value is Fine.

1. Press the Up/Down buttons to select the Quality option in the Setup menu.
2. Press the OK/MENU button.
3. Press the Up/Down buttons to select a Quality option from the menu that appears:



4. Press the OK/MENU button to confirm, save and exit to the camera standby mode.
5. The Quality icon for the option you selected appears on the bottom left corner of the LCD.



Super quality



Fine quality



Normal quality

Digital Zoom

You can set the digital zoom function On or Off.

1. Press the Up/Down button to select the Digital Zoom option in the Setup menu.
2. Press the OK/MENU button.
3. Press the Up/Down button to select *On* or *Off*.
4. Press the OK/MENU button to confirm, save and exit to the camera standby mode.
5. The Zoom icon on the right side of the LCD will appear with or without the Digital zoom upper section depending on what you selected.

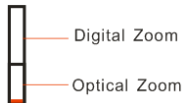

Date

This allows you to set the system time which will be displayed on the photos.

1. Press the Up/Down buttons to select the Date option in the Setup menu.
2. Press the OK/MENU button.
3. Press the Up/Down buttons to select a Date option from the menu that appears:



- On selecting "On" the date will appear on the photo once it is taken.
- On selecting "Off" no date will appear on the photo.
- On selecting "Set Date" the Set Date settings screen will appear. You will be able to change the date settings that will appear on the photo once it is taken.

To Set the date:

1. Press the Up/Down button to enter the Set Date option.
2. Press the OK/MENU button.
3. Press the Right/Left button to select and highlight the Year, Month, Day, Hour, Minute, Second and Date Format type.
4. Press the Up/Down button to set the Date and Time digits.
5. Select the first option of the Date format and press the Up/Down button to set the date format that appears on the top line: *YY MM DD*; *DD MM YY*; *MM DD YY*.

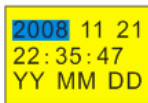

6. Press the OK/MENU button to confirm, save the changes and exit.

Auto Power Off

By default, if your camera is idle for 60 seconds it will automatically be powered off. Use the Auto Power Off option to change this setting:

1. Press the Up/Down button to select the Auto Power Off option in Setup menu.
2. Press the OK/MENU button.
3. Press the Up/Down buttons to select an Auto Power Off option from the menu that appears:



4. Press the Up/Down button to select a time that the camera will automatically power off if inactive.
Note: If you select None, the camera will not be powered off until the battery power is depleted or the camera is turned off manually.
5. Press the OK/MENU button to confirm, save and exit to the camera standby mode.

Language

Your digital camera supports English menu language, please refer to the latest version for more languages.

Frequency

Select the light frequency for the local environment. Generally, 60HZ is for the U.S. and 50HZ for Europe and Japan. The default setting is 60HZ

1. Press the Up/Down button to select the Frequency option from the Setup menu.
2. Press the OK/MENU button.
3. Press the Up/Down buttons to select a Frequency option from the menu that appears:

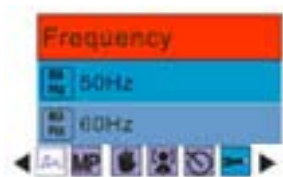

4. Press the OK/MENU button to confirm, save and exit to the camera standby mode.

Format

This function will format the memory card and will erase all files in memory including files that have been protected.

Important: Please use this function with caution. Once formatted all the images stored in the memory will be erase. This process is irreversible. Please download all images to the PC before formatting the card.

1. Press the Up/Down button to select the Format option from the Setup menu.
2. Press the OK/MENU button.

3. Press the Up/Down button to select *OK* to continue with the format or *Cancel* to exit.

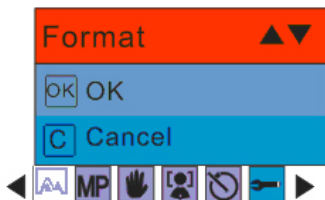

4. Press the OK/MENU button to confirm.
5. If you selected OK, a Format confirmation message appears.



6. Press the Right/Left button to select “Yes” to format, “No” to exit.
7. Press the OK/MENU button to confirm and begin the format.
8. Once the SD card is formatted all the images sitting on the card will be erased and the camera will revert to the camera standby mode.

Default Setting

You can restore your camera to the original factory settings.

1. Press the Up/Down button to select Default Setting in the Setup menu.

2. Press the OK/MENU button.
3. Press the Up/Down button to select OK

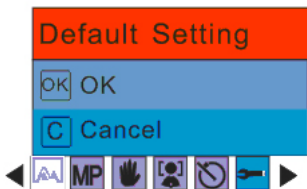

4. Press the Up/Down button to select OK to set to default setting or Cancel to exit.
5. Press the OK/MENU button to confirm.
6. If you selected OK, a Default Setting confirmation message will appear:

Default Setting

Yes

No

7. Press the Right/Left button to select “Yes” to reset to the default setting or “No” to exit the menu.
8. Press the OK/MENU button to confirm and reset the camera to the original factory settings.

Video Mode

Press the MODE button to select the Video mode.

Note: The camera has limited internal memory and does not allow recording videos without an SD card inserted. An SD card (up to 8GB) needs to be inserted in order to use the video mode normally.

When the  icon appears on the top left corner of the LCD screen this indicates that you are in Video mode.

1. Prepare the object or subject you wish to record.
2. Press the Shutter button to begin shooting the video.
3. The elapse time will appear on the top right of the LCD screen and the icon  will flash on the LCD screen.
4. Press the Shutter button again to stop the recording and save this file in AVI format.

Note:

1. You can preview the AVI files in Playback mode or once downloaded to your computer by using Quick Time and Windows Media Player.

- When the camera's memory is full, the “Memory Full Insert a SD Memory Card to Transfer and Shoot More video!” message will appear on the LCD screen when you attempt shoot more videos. Download the test file from the internal memory to the PC or delete them to shoot more videos. Alternatively, you can insert a SD memory card to expand the memory to record longer videos.

In Video mode there are 3 setup options - *White Balance, Size and Macro*

White Balance

You can select 5 different White Balance light conditions for shooting videos.

- Press the OK/MENU button.
- Press the Right/Left button to select the **WB** option.
- Press the Up/Down buttons to select a White Balance option from the menu that appears:

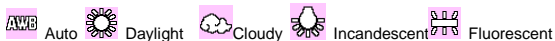

4. Press the OK/MENU button to confirm, save and exit to the video standby mode.
5. The LCD screen will be adjusted as per the White Balance option you selected.

Size

Your camera supports 2 video resolutions- 640x480 (VGA) pixels, 320x240 (QVGA) pixels.



1. Press the OK/MENU button.
2. Press the Right/Left button to select the  option for the Size menu to appear.
3. Press the Up/Down buttons to select an Image Size option from the menu that appears:
VGA 640x480
QVGA 320x240
4. Press the OK/MENU button to confirm, save and exit to the video standby mode.
5. The Image Size icon selected will appear at the top of the LCD screen.

Macro

The camera has the function that allows you to capture objects either at very near or very far distances.

Use the Macro close up for shooting up to 80cm:

1. Press the OK/MENU button

2. Press the Right/Left button to select the  option for the Macro menu to appear.
3. Press the Up/Down buttons to select a Macro option from the menu that appears
 : Macro shooting - On
 : Far shooting - Off
4. Press the OK/MENU button to confirm, save your choice and exit to the video standby mode.
5. The selected Macro icon appears on the top of the LCD screen.

Playback Mode

Press the MODE button to enter the Playback mode.

When the  icon appears on the top left corner of the LCD screen this indicates that you are in Playback mode.

Here you can preview the photos and videos you have captured and recorded. In Playback mode you can rotate, protect, delete and crop your photos and you can protect and delete video clips. You can also print photos directly from your camera using PictBridge.

Note: The message “No File Exist” will appear on the LCD screen if there are no photos or videos in your camera. Press the MODE button to return to the camera or video mode and begin to take photos or videos.

Full screen to Thumbnail display

When the camera is in the Playback Mode and an image appears on the LCD screen:

1. Press the W button.
2. This will open up the thumbnail display.
3. Press the Up/Down/Left/Right buttons and select a thumbnail of a photo or video.
4. Press the OK/MENU button to display the photo or video in full screen.

Zoom In or Out of the Photo

1. Select a JPEG photo.
2. The icon  will display on the top left corner of the LCD screen.
3. Press the T button to zoom into the photo.
4. Press the Up/Down/Left/Right button to navigate around the photo.
5. Press the W button to zoom back out it.

Operation functions for still photos

Select the still photo you want by either selecting it in the thumbnail view first before viewing it in full screen or view the images one by one in your camera by pressing the Right/Left buttons to toggle through the images that appear on the LCD.

Select the photo you wish to *rotate, protect, delete, crop or print*.

Rotate

The rotate feature will only work for images on the SD card that is inserted.

1. Press the OK/MENU button.
2. Press the Right/Left button to select the  rotate option.
3. Press the Up/Down buttons to select the Rotate option from the menu that appears.

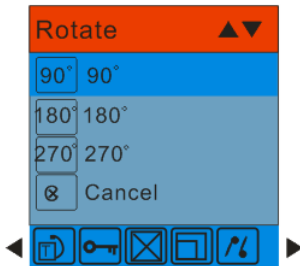

4. Press the OK/MENU button to confirm how many degrees you want to rotate the photo
5. A “Rotate & Saving” message will appear on the screen. Please wait while the photo is rotated as per your choice.
6. The photo will now be rotated and saved.

Note:

1. You cannot rotate a protected file. On attempting to rotate a protected file a “This File is Write-Protected” message will appear on the screen.
2. “No card inserted” will appear on the screen if no SD card is insert. Please insert an SD memory card to use this function.

Protect

You can protect your photos/videos from accidental deletion by selecting the “lock” feature.

1. Press the OK/MENU button.
2. Press the Right/Left button to select the  protect option.
3. Press the Up/Down button to select the Protect options that appear in the menu.



4. Press the OK/MENU button.

5. If you select Lock, a lock icon  will appear at the top of the LCD for the photo or video selected.

Note: To “Unlock” the current file follow steps 1 through 4. Select “Unlock” and press the OK/MENU button to unlock the current file.

Delete

Delete unwanted photos and videos at any time in order to free up memory. You can delete one image or video clip at a time or delete all except the protected photos and videos that are currently stored and saved on the memory card.

1. Press the OK/MENU button.

2. Press the Right/Left button to select the  Delete option.

3. Press the Up/Down button to select “This Image” (if the image is a photo) or “This Video” (if the image is a video) to delete the current photo or video you selected. Select the “All” option to delete all unprotected (unlocked) images. Press Cancel to exit the Delete option if you do not wish to delete anything at this stage.

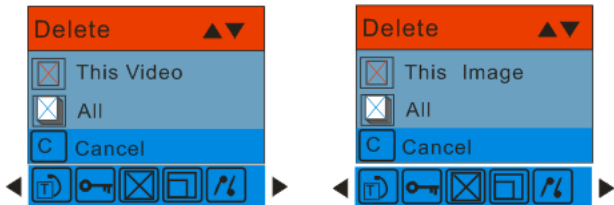

4. Press the OK/MENU button to confirm.
5. A Delete confirmation message appears.
6. Press the Right/Left button to select “Yes” or “No”.
7. Press the OK/MENU button to confirm and delete the image(s).

Note: You cannot delete files that are locked.

Caution: If you choose the All option, all the unprotected photo images on your SD card will be deleted.

This process is irreversible and all your images will be lost forever unless you have saved them or downloaded them to your computer previous to the deletion.

Crop Image

Crop your photos to show and save a specific portion of an image or to highlight certain focal points. The Crop feature lets you zoom in on an image and then save that part of the image as a new photo.

Note: Only photos on the SD Card can be cropped.

1. Press the OK/MENU button.

2. Press the Right/Left button to select the  Crop option.

3. Press the Up/Down button to select *Crop* or *Cancel*.

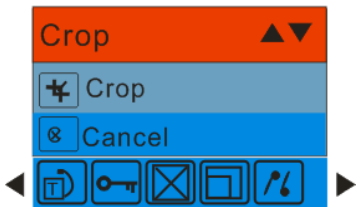

4. Press the OK/MENU button.

5. A blue crop rectangle appears on the photo in the LCD screen.

6. Press the W or T buttons to determine the size of the area to crop.

7. Press the Up/Down/Right/Left buttons to navigate the area of the photo you wish to crop.

8. Press the Shutter button for the crop confirmation icons to appear or press the OK/MENU button to exit.

9. Press the Shutter button to confirm and save the crop or press the OK/MENU button to exit.

10. A Saving screen appears before the cropped photo is saved as a new photo to your camera's memory card.

Print with Pictbridge

You can print the photos directly from the camera with a Pictbridge compatible printer.

1. Select the photo you wish to print.
2. Press the OK/MENU button.
3. Press the Right/Left button to select the  Pictbridge menu.
4. Press the Up/Down button and select Pictbridge to print photos or press Cancel to exit the menu.

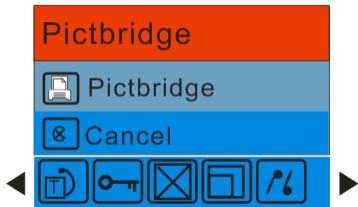

5. Press the OK/MENU button to enter the Pictbridge mode.
6. A message will appear on the LCD to "Please connect to device".
7. Connect your camera to a compatible printer with the USB cable.
8. Please follow the camera indication and select the menu to print the photo.

Playing the AVI video file

1. In Playback mode, press the Left/Right buttons to select an AVI video file you wish to play.

- Alternatively, press the W button to enter the thumbnail mode and select a video.
Note: Videos have an  icon on top left corner of the file or on the thumbnail.
- Press the OK/MENU button for the selected video to appear in full screen.
- Press the Shutter button to play the current AVI file.
- Press the Shutter button to pause and press it again to continue playing.
- Press the Up button to stop playing the AVI and revert back to the Playback mode.

Note: Just as with Photos so too Videos can be protected from accidental deletion.

Protect

You can protect your videos from accidental deletion by selecting the “Lock” feature.

- Press the OK/MENU button.
- Press the Right/Left button to select the  protect option.
- Press the Up/Down button to select the Protect options that appear in the menu.



4. Press the OK/MENU button.
5. If you select Lock, a lock icon  will appear at the top of the LCD for the video selected.

Note: To “Unlock” the current file follow steps 1 through 4. Select “Unlock” and press the OK/MENU button to unlock the current file.

Delete

Delete unwanted videos at any time in order to free up memory. You can delete one image or video clip at a time or delete all except the protected videos that are currently stored and saved on the memory card.

1. Press the OK/MENU button.
2. Press the Right/Left button to select the  Delete option.
3. Press the Up/Down button to select “This Image” (if the image is a photo) or “This Video” (if the image is a video) to delete the current photo or video you selected.
4. Select the corresponding “All” option to delete all unprotected images. Press Cancel to exit the Delete option if you do not wish to delete anything at this stage.

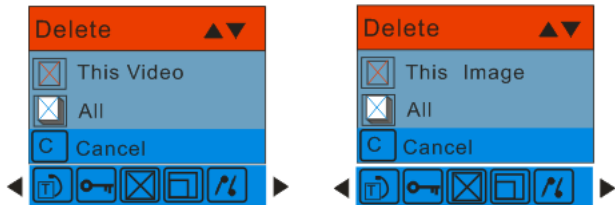

5. Press the OK/MENU button to confirm.
6. A Delete confirmation message appears.
7. Press the Right/Left button to select “Yes” or “No”.
8. Press the OK/MENU button to confirm and delete the image(s).

Note: You cannot delete files that are locked.

Caution: If you choose the All option, all the unprotected video images on your SD card will be deleted.

This process is irreversible and all your images will be lost forever unless you have saved them or downloaded them to your computer previous to the deletion.

Download photos and videos to your PC

Transfer Photo and Video images from your camera to your PC using PhoTags Express.

Select the “**Get Photos**” button from the top of the PhoTags Express Main Menu screen.



The Get Photos Wizard opens.

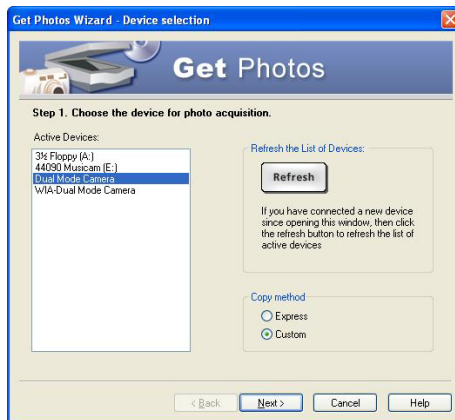

Select the device (removable disk) option in the Active Devices window on the left and then select either the "Custom" or "Express" copy radial button in the Copy methods box.

Note: If you do not see your camera in the list press the **Refresh** button.

CUSTOM COPY METHOD

Select the “**Custom**” copy radial button. Click the “**Next**” button.

Add Active Captions to your pictures. You can add a date, keywords, categories and more. Click “**Next**” to continue.



Choose where to place your photos and videos. The default is to place all photos and videos into a folder under the C:\My Documents\ My Pictures folder with the date when the photos were taken as the folder name.

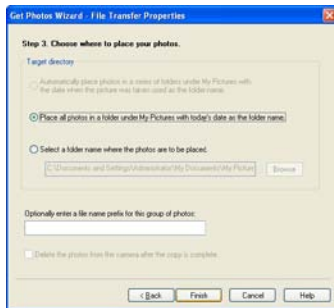

Click the “Finish” button to start the download process.

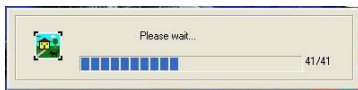

A photos download progress bar appears showing the number of media (videos included) downloading to your computer.

PhoTags Express - C:\Documents and Settings\mk-ha\My Documents\My Pictures\14044056.DSCF0128.jpg

1 Select Photos 2 Enhance Photos 3 Add Captions 4 Share Photos 5 Work Shop

PhoTags express

My Pictures

- 2004-05-31
- 2004-06-28
- 2004-07-07
- 2004-07-18
- 2004-08-15
- 2004-08-21
- 2004-09-01
- 2004-Nov-09
- 2004-Nov-01
- 2004-Nov-04
- 2004-Nov-14
- 2004-Oct-25
- 2004-Oct-31
- 2004-Sep-30
- Active Captions
- Alex
- Calendars
- Cameras
- Copy of 2004-10-19
- Corbu
- DE
- delete
- Folder
- Family
- Flowers
- For Work
- France
- hibu

Now Learn to Use PhoTags

Hong Kong 8-04005.JPG Hong Kong 8-04007.JPG Hong Kong 8-04009.JPG

Hong Kong 8-04015.JPG Hong Kong 8-04020.JPG Hong Kong 8-04030.JPG Hong Kong 8-04055.JPG

Hong Kong 8-04064.JPG Hong Kong 8-04069.JPG Hong Kong 8-04070.JPG Hong Kong 8-04073.JPG

Sort By: Name Data

Manage Collections

Artistic Photos
hibu
My Pictures
misc
Taxes and handouts
test

Add Remove
Add All Organize
Clear

Ready Collector: 3/24/2004 130 photos Dimensions: 2048 x 1536

All the media – Photos and Videos on your camera are now downloaded to your computer to the selected folder.

Open the “**Select Photos**” mode of PhoTags Express to view the thumbnails for all the media.

You may now use PhoTags Express to edit your photos, create collections and Burn CD`s.

To learn more of how to get the most out of your PhoTags application select the “**Show Me How**” or the “?” Help Guide button found on the top right of the screen.

EXPRESS COPY METHOD

Select the “**Express**” copy radial button if you want to have all the images transferred to the PC without the option to select which photos you want to transfer.

In this mode you will not see a preview of the images transferred. For more information please refer to the Help Guide in PhoTags Express.

Viewing Videos

Once the videos have downloaded from the camera to the PC, open any application that will enable you to view the video files (for example Windows Media Player).

Videos created and downloaded should be sitting in the C:\My Documents\My Pictures\{date} folder.

Videos are saved in AVI format. Double click on a video with the avi extension.

The video will begin to play automatically. To replay the video, use the media controls.

Once all the Photos and Videos have been downloaded to the computer it is recommended that you delete them from the camera thereby preparing your camera to take more photos and videos.

Transferring photos and videos to your PC manually

Turn on your camera, Change your camera mode to **Playback** and connect your camera to the computer correctly with USB cable, the screen will be shown a window (**Removable Disk F:**) as below:

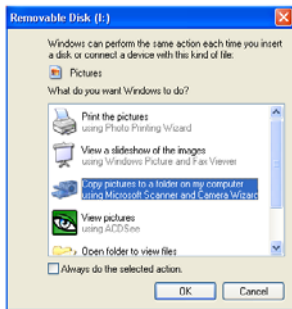

NOTE: Now you can download the photos and videos to your computer with two methods as below:

1. Download photos directly from windows

Choose “**copy pictures to a folder on my computer**” on the **Removable Disk (F:)** window. After you click “**OK**”, step by step instructions will appear. Follow the description and click the buttons that are defaulted by the system to finish transferring.

2. Alternatively you can:

1. Click on the MY COMPUTER Icon on the desktop.
2. Your memory card will appear as a REMOVABLE STORAGE DEVICE.
3. Click on the REMOVABLE STORAGE DEVICE to view the images. The images are stored in the subfolder called DCM100.
4. You can now copy and paste the images to any directory you choose.

Transferring photos and videos to your MAC manually

The Photags Express software is not compatible and will not install on a Mac.

In order to transfer photos and videos from your camera to your Macintosh computer:

1. Plug the camera into an available USB port
2. A new drive should mount on the desktop which stores any photos or videos that have been taken.

Maintenance of Your Digital Camera

The digital camera is a delicate device. Please handle your camera with care to avoid damaging it.

Do not expose your camera to heat sources.

Do not use your camera in wet or moist conditions.

Appendix A: Technical Specifications

Image Sensor	CMOS Sensor
Image Resolution	3264x2448(8MP), 3648x2048(7MP) HD, 2592x1944(5MP), 2048x1536(3MP), 1920x1080(2MP) HD, 640x480(VGA)
Video Resolution	640X480 pixels,320X240pixels
File Format	JPEG/AVI
External Memory	SD Card (up to 8GB)
LCD Display	2.4 Inch TFT
Lens	Auto Focus Zoom Lens
Zoom	Optical Zoom; 8X Digital Zoom
Exposure	-3.0EV ~ +3.0EV
White Balance	Auto, Daylight, Cloudy, Incandescent , Fluorescent
ISO	Auto/100/200/400
Scene	Auto/Night Portrait/Night Scenery/Portrait/Scenery/Sport/Party/Beach/High Sensitivity
Flash	Auto /Force/Red Eye Reduction/Off
Self-timer	2, 5 or 10 sec delay
Anti-Shake	Yes
PictBridge	Yes
Face Detect	Yes
Interface	USB 2.0
System Requirements	Window XP/ Vista/ Mac OS X (10.2.6 or higher)
Battery	Lithium rechargeable battery
Working Temperature	0~40 °C

Appendix B: Troubleshooting

Q: I have taken photos but my computer says, “No photos in camera.” What do I do?

A: First ensure that you have in fact taken photos. Press the Shutter button a few times to take some sample photos and then try downloading them again.

If you still get a “no photos” error this may mean that your computer may not meet the minimum system requirements:

At least a Pentium III 300Mhz, AMD Athlon 300Mhz or a Celeron 400MHz or higher as well as at least 128 MB ram. Please note that the older AMD K6 processors will not work. More information about determining your computer’s specifications can be found in the General Computer Information section.

Q: How do I make sure I don't lose important pictures?

In order to use your camera properly you will need to insert a SD card of up to 8GB. All your images will be stored on this card. It is recommended to download the images from the card as often as possible, so as to free up space on the card. This also is a backup if your card gets lost or damaged.

The test photo is saved in limited SDRAM, which requires a constant electric current to store your photos. Should your camera lose power (for instance if the battery dies or run out of power) the test picture will be lost. We recommend always downloading your photos to your computer as soon as possible to prevent unintentional data loss.

Q: If I have a MAC, will the device work?

The device will work as a removable drive on Mac OS X (10.2.6 or higher). And images can be accessed manually.

A00-090418NES